

50 Hz



ecocirc[®] PRO Series

WET ROTOR CIRCULATORS
FOR SANITARY SYSTEMS

Cod. 191007211 Rev.A Ed.09/2013

 **LOWARA**
a xylem brand

**ecocirc® PRO SERIES
INSTALLATION POSITIONS**

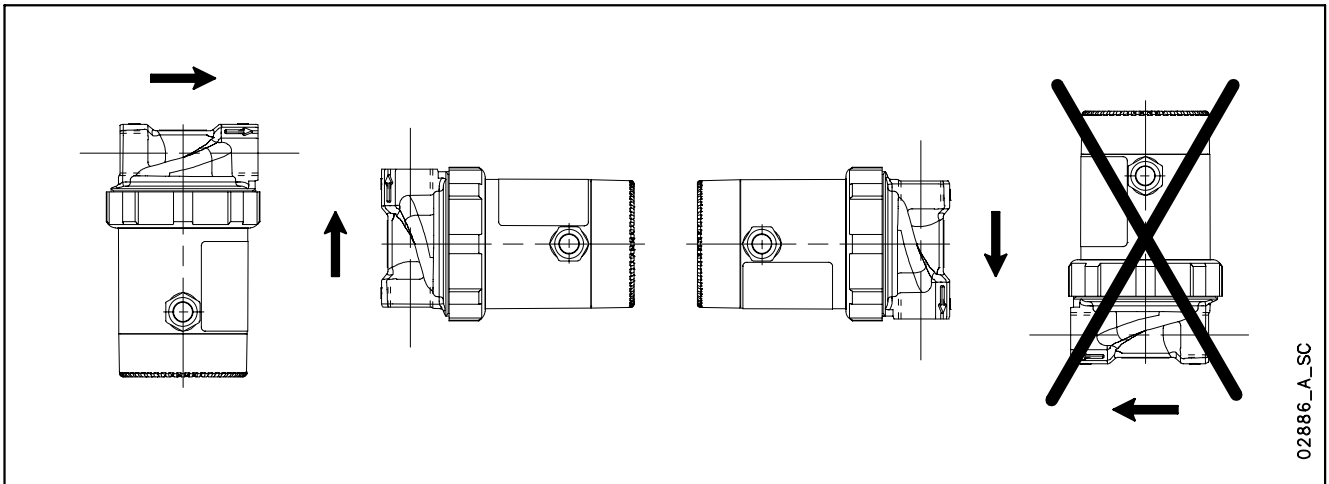

High efficiency electronic sanitary circulators

MARKET SECTORS

RESIDENTIAL.

APPLICATIONS

- Hot water circulation.

ecocirc® PRO SERIES



SPECIFICATIONS

PUMP

- **Flow rate:** up to 1 m³/h.
- **Head:** up to 3 m.
- **Temperature of pumped liquid:** +2°C ÷ +65°C.
Avoid condensation and ice formation.
- **Maximum operating pressure:** 10 bar (PN 10).
- **Rotor assembly group:** made of stainless steel/composite material/carbon.

MOTOR

- Permanent magnet EC (Electronically Commutated) type motor with spherical rotor/stator.
- Wet rotor with a single spherical ceramic/carbon ball bearing.
- Integrated motor protection; no external protection required.
- Single-phase 200-240V 50/60 Hz power supply.
- Motor type:
 - Fixed speed for temperature sensor and temperature sensor + timer models;
 - Variable speed with automatic regulation for basic and timer models.
- **Insulation class** F (155°C).
- **Protection class:** IP 44 no-timer models.
IP 42 timer models.

**ecocirc® PRO
SERIES****CONSTRUCTION CHARACTERISTICS**

- Electric circulator pumps for domestic hot water applications at maximum temperature of 65°C, at maximum hardness of 25° f (14°dH).
- Brass pump body for direct installation onto piping for 1/2" and 1/2" - 1" 1/4" threaded union connections.
- The design is based on spherical rotor/stator technology.
This means that:
 - The only moving part is the spherical rotor/impeller unit that turns on a hard ceramic ball.
 - Shaft seals or conventional bearing bushings with a shaft have been eliminated for a single self realigning spherical bearing.
- Blockage free rotor: the spherical motor principle does not require a manual unblocking device thanks to the small touching surface of the bearing on the ball. The starting torque required is minimal.
- Air-purge functionality:
an automatic and quick routine to remove the air from the circulator and ensure safe operation.
- "Stand-by" mode.
- Self diagnostic and malfunction detection:
defects detected by the pump system are signalled with alternating LED light flashes.
- Insulation shell as a standard.
- Models available:
 - Fixed speed
 - Temperature sensor to maintain the water onto piping at the required temperature . The circulator automatically turns off when the water temperature achieves the value. Temperature can be set up between 20°C and 70°C by the selector on the motor.
 - Temperature sensor and timer for more energy saving.
 - Variable speed:
 - Performances optimized by system requests. Speed set up is done by a selector on the motor by 7 different positions. At 2 and 3 positions (ECO) the consumption is especially low.
 - Timer as a standard in order to daily set up the performances.
- 110 mm port-to-port length models are fitted out with non-return and shut off valve. 65 mm port-to-port length models are fitted out with a non-return valve to install to supply connection.
- According to EN standards 60335-1, 60335-2-51, 55014-1, 55014-2.

ACCESSORIES

- Pipe unions.

INSTALLATION

- Suitable for installation in vertical or horizontal piping, in this last case not with the motor housing upward.

ecocirc® PRO SERIES IDENTIFICATION CODE

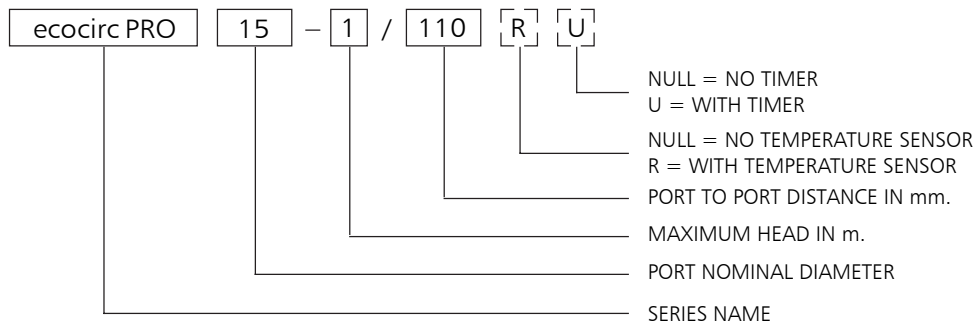

EXAMPLE : ecocirc PRO 15-1/110 RU

Electronic circulator of the ecocirc PRO series, port nominal diameter = 15, max head = 1 m, port to port distance 110 mm, with temperature probe and timer.

TABLE OF MATERIALS

PART	MATERIAL
Pump body	Brass
Rotor assembly group	Stainless steel
	Composite material
Bearing	Carbon
Gaskets	Ceramic
	EPDM

eb-50-en_b_tm

Regulations (EC) n. 641/2009 and (EU) n. 622/2012 – Annex I – point 2 (Product information requirements)

- a) Energy efficiency index: note not applicable to these products.
- b) "The benchmark for most efficient circulators is $EEI \leq 0,20$ ": note not applicable to these products.
- c) Information relevant for disassembly, recycling or disposal at end-of-life: observe the current laws and by-laws governing sorted waste disposal. Consult the product operating manual.
- d) Information for circulators specifically designed to potable water uses: "This circulator is suitable for drinking water only".

ecocirc® PRO SERIES HYDRAULIC PERFORMANCE TABLE

PUMP TYPE ecocirc PRO 230V 50Hz	POWER ABSORBED		SPEED	Q = DELIVERY										
	MIN W	MAX W		l/s 0	0,03	0,06	0,08	0,11	0,14	0,19	0,22	0,28	0,36	0,39
				m ³ /h 0	0,1	0,2	0,3	0,4	0,5	0,7	0,8	1	1,3	1,4
H = TOTAL HEAD METRES COLUMN OF WATER														
15-1/65 R	5,9	7,5	max	1,05	1,04	1,00	0,94	0,86	0,76	0,46	0,25			
15-1/65 RU	7,4	9,0	max	1,05	1,04	1,00	0,94	0,86	0,76	0,46	0,25			
15-1/110 R	5,8	7,3	max	1,05	0,95	0,83	0,69	0,51	0,29					
15-1/110 RU	7,3	8,8	max	1,05	0,95	0,83	0,69	0,51	0,29					
15-1/65	2,6	2,7	min	0,20	0,18	0,15	0,10							
	5,9	7,5	max	1,05	1,04	1,00	0,94	0,86	0,76	0,46	0,25			
15-1/65 U	4,1	4,2	min	0,20	0,18	0,15	0,10							
	7,4	9,0	max	1,05	1,04	1,00	0,94	0,86	0,76	0,46	0,25			
15-1/110	2,2	2,3	min	0,10										
	5,8	7,3	max	1,05	0,95	0,83	0,69	0,51	0,29					
15-1/110 U	3,7	3,8	min	0,10										
	7,3	8,8	max	1,05	0,95	0,83	0,69	0,51	0,29					
15-3/65	2,6	2,6	min	0,25	0,24	0,20	0,12							
	17,1	23,7	max	3,10	3,09	3,08	3,07	3,06	3,04	3,02	3,00	2,97	2,91	2,89
15-3/110	4,0	4,0	min	0,20	0,11									
	17,1	26,6	max	3,31	3,20	3,08	2,96	2,84	2,71	2,43	2,28	1,96		

Hydraulic performances in compliance with ISO 9906:2012 - Grade 3B (ex ISO 9906:1999 - Annex A)

ecocirc-PRO-50-en_e_th

ecocirc® PRO SERIES SINGLE-PHASE OPERATING CHARACTERISTICS

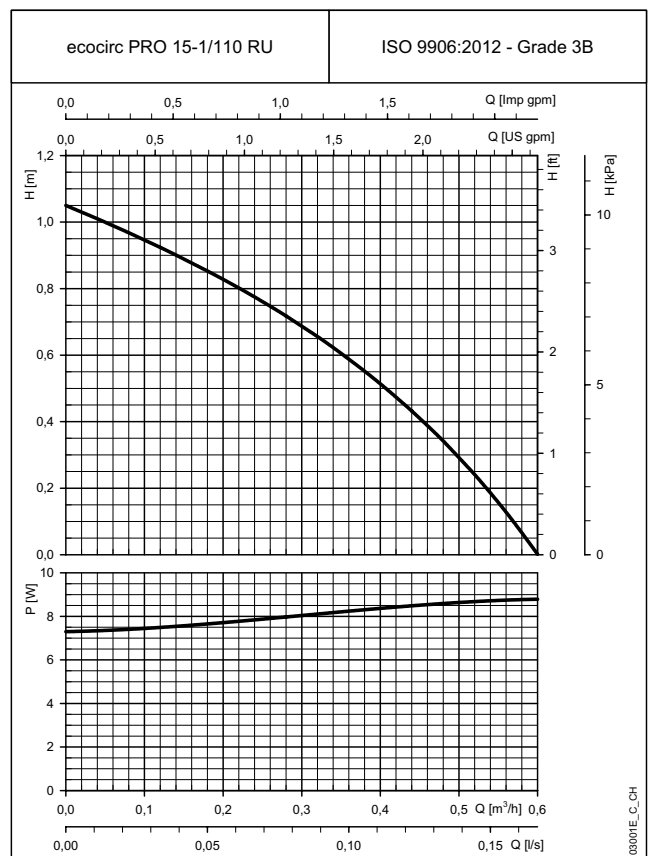
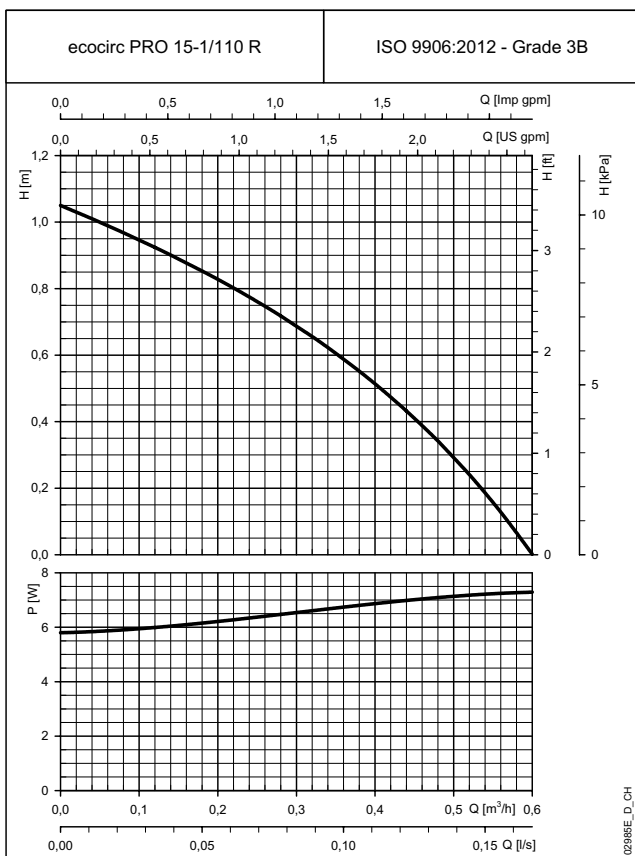
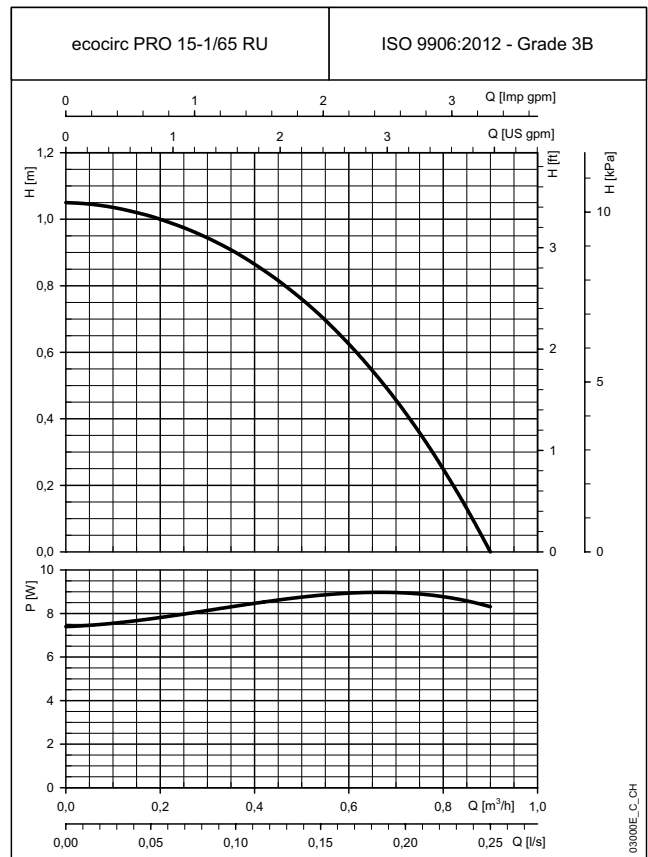
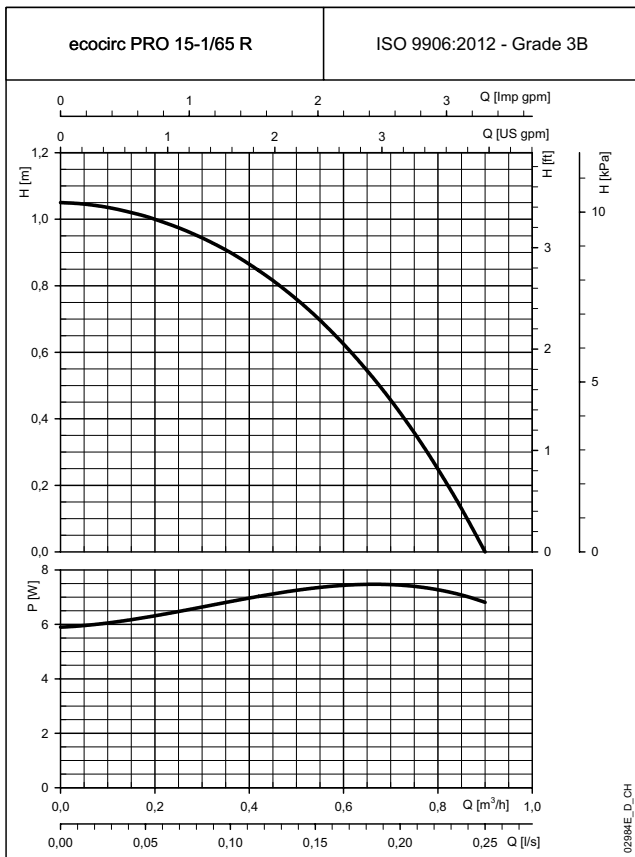

These performances are valid for liquids with density $\rho = 1.0 \text{ Kg/dm}^3$ and kinematic viscosity $\nu = 1 \text{ mm}^2/\text{sec}$.

ecocirc® PRO SERIES
SINGLE-PHASE OPERATING CHARACTERISTICS

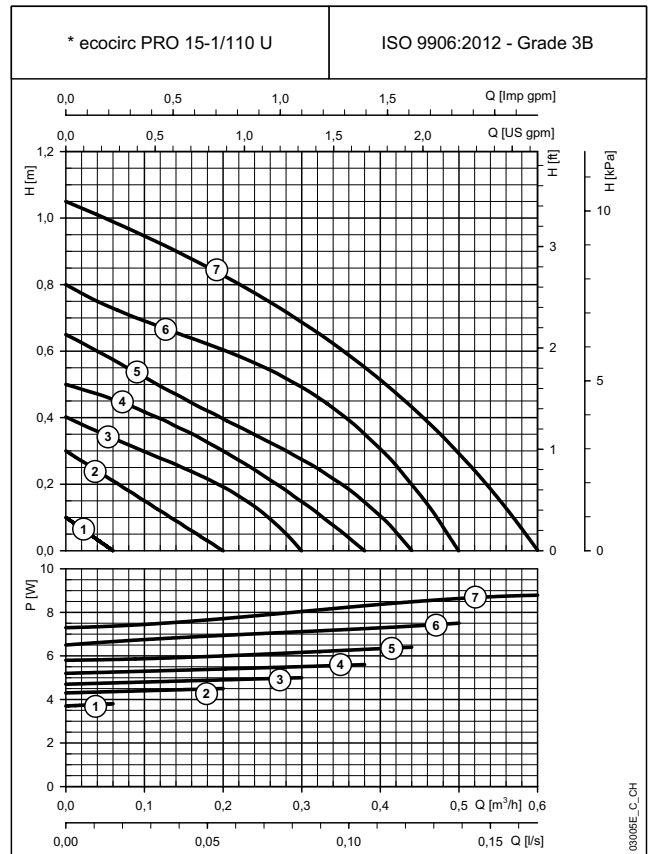
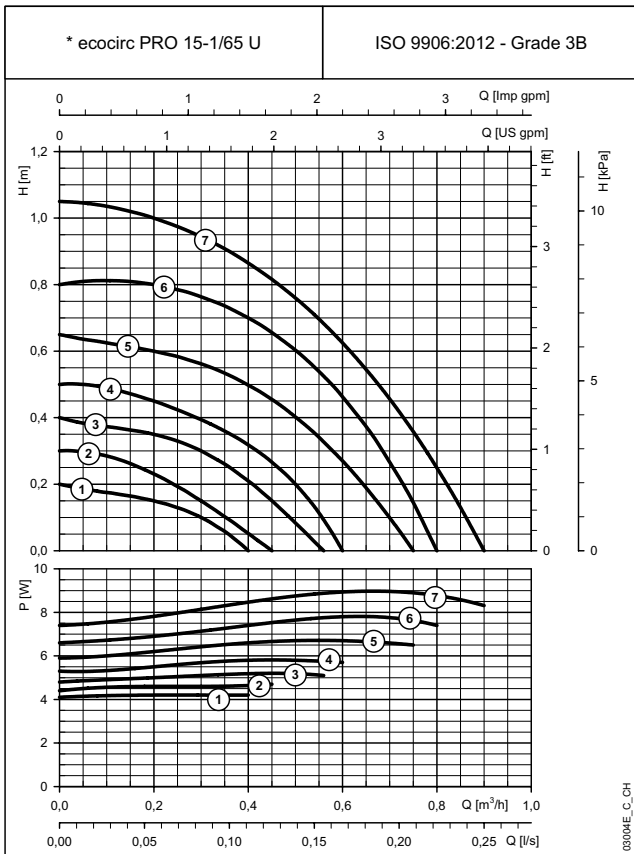
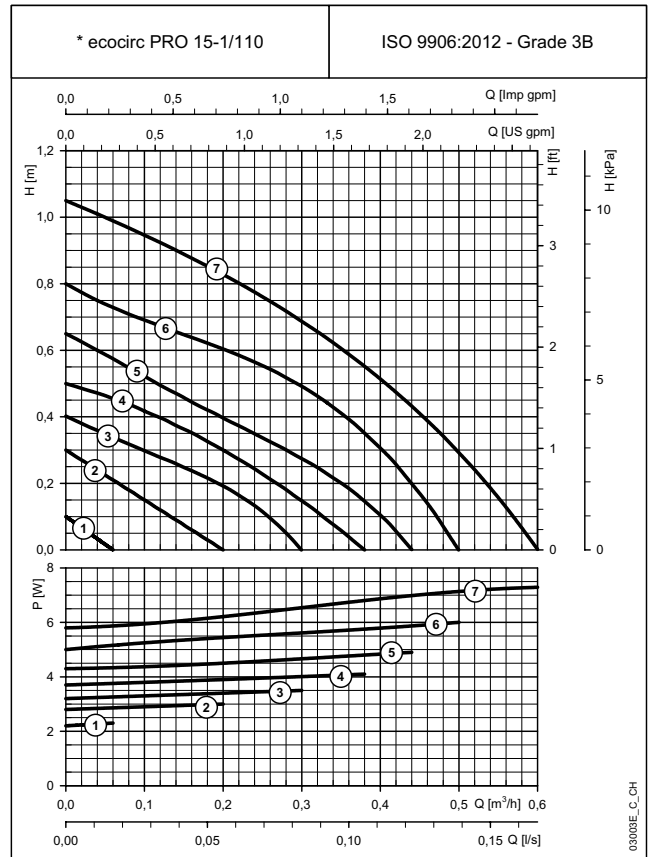
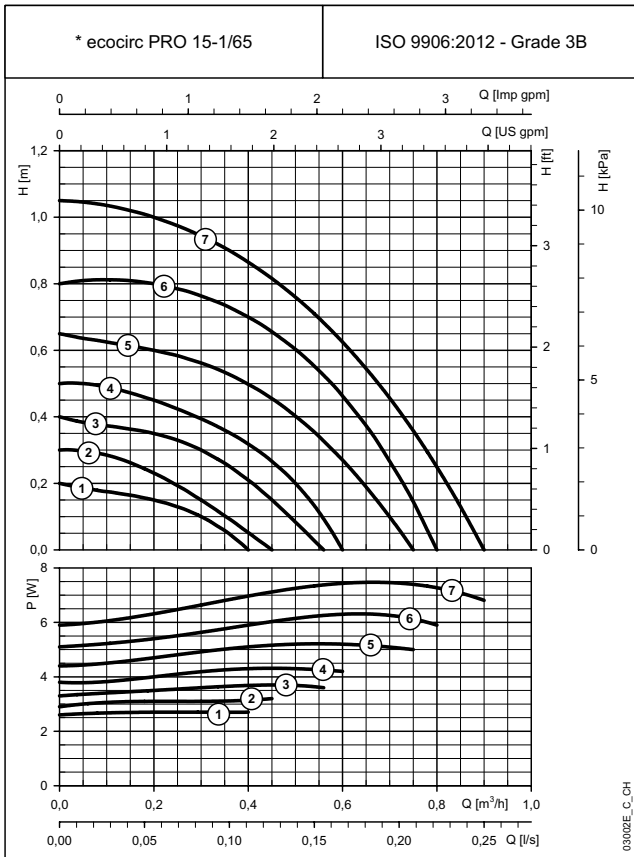

These performances are valid for liquids with density $\rho = 1.0 \text{ Kg/dm}^3$ and kinematic viscosity $\nu = 1 \text{ mm}^2/\text{sec}$.
* Pump operates steplessly. Lines correspond to knob settings and are for reference only.

ecocirc® PRO SERIES
SINGLE-PHASE OPERATING CHARACTERISTICS

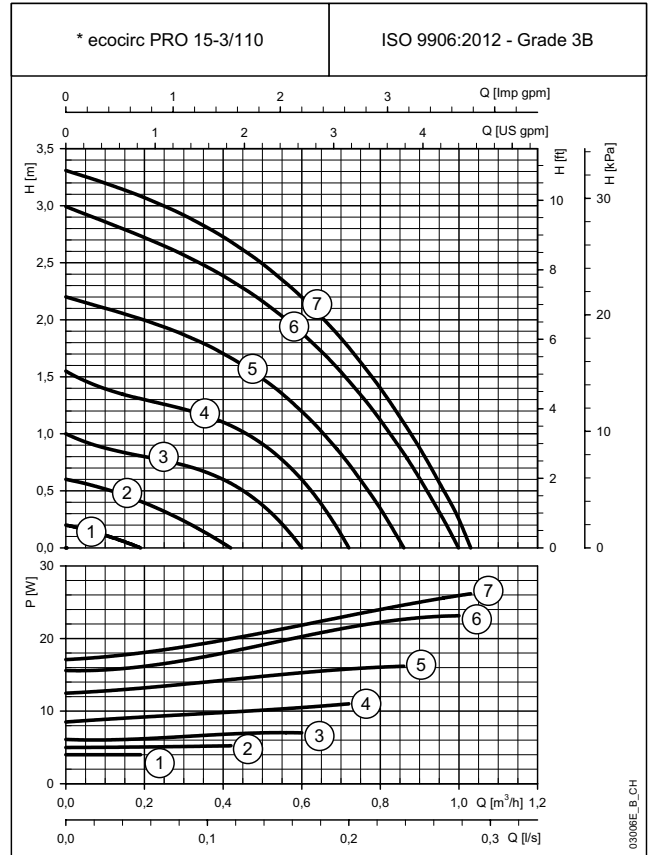
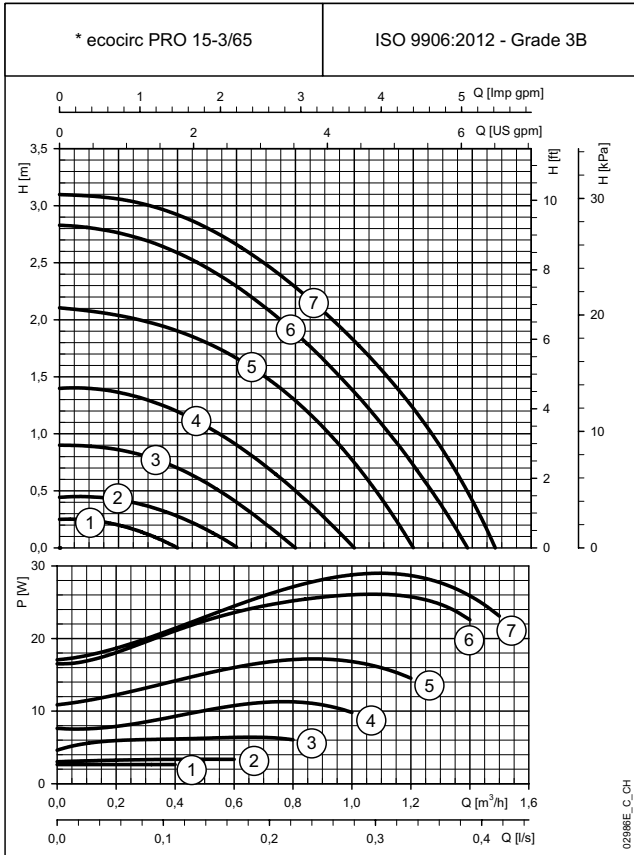

These performances are valid for liquids with density $\rho = 1.0 \text{ Kg/dm}^3$ and kinematic viscosity $\nu = 1 \text{ mm}^2/\text{sec}$.
* Pump operates steplessly. Lines correspond to knob settings and are for reference only.

ecocirc® PRO SERIES DIMENSIONS AND WEIGHTS

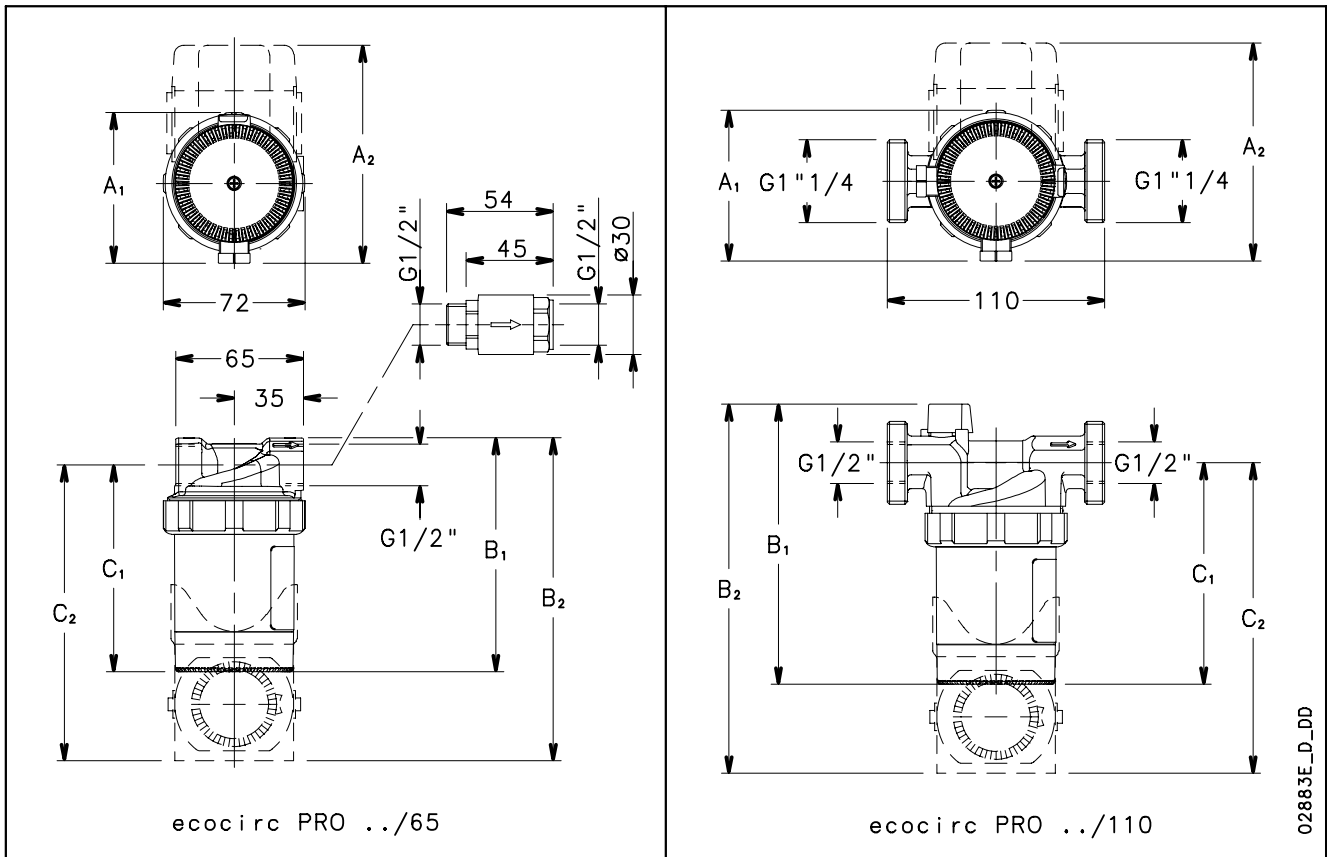

DIMENSIONS AND WEIGHTS TABLE

PUMP TYPE ecocirc PRO		DIMENSIONS (mm)						DN	PESO kg
		A ₁	A ₂	B ₁	B ₂	C ₁	C ₂		
15-1/65R	15-1/65	76	-	118	-	105	-	15	0,9
15-1/65RU	15-1/65U	-	110	-	163	-	150	15	1
15-1/110R	15-1/110	76	-	142	-	112	-	15	1,3
15-1/110RU	15-1/110U	-	110	-	187	-	157	15	1,4
	15-3/65	76	-	118	-	105	-	15	0,9
	15-3/110	76	-	142	-	112	-	15	1,3

ecocirc-PRO-2p50-en_d_td

TECHNICAL APPENDIX

VAPOUR PRESSURE VAPOUR PRESSURE p_s AND ρ DENSITY OF WATER TABLE

t °C	T K	p_s bar	ρ kg/dm ³	t °C	T K	p_s bar	ρ kg/dm ³	t °C	T K	p_s bar	ρ kg/dm ³
0	273,15	0,00611	0,9998	55	328,15	0,15741	0,9857	120	393,15	1,9854	0,9429
1	274,15	0,00657	0,9999	56	329,15	0,16511	0,9852	122	395,15	2,1145	0,9412
2	275,15	0,00706	0,9999	57	330,15	0,17313	0,9846	124	397,15	2,2504	0,9396
3	276,15	0,00758	0,9999	58	331,15	0,18147	0,9842	126	399,15	2,3933	0,9379
4	277,15	0,00813	1,0000	59	332,15	0,19016	0,9837	128	401,15	2,5435	0,9362
5	278,15	0,00872	1,0000	60	333,15	0,1992	0,9832	130	403,15	2,7013	0,9346
6	279,15	0,00935	1,0000	61	334,15	0,2086	0,9826	132	405,15	2,867	0,9328
7	280,15	0,01001	0,9999	62	335,15	0,2184	0,9821	134	407,15	3,041	0,9311
8	281,15	0,01072	0,9999	63	336,15	0,2286	0,9816	136	409,15	3,223	0,9294
9	282,15	0,01147	0,9998	64	337,15	0,2391	0,9811	138	411,15	3,414	0,9276
10	283,15	0,01227	0,9997	65	338,15	0,2501	0,9805	140	413,15	3,614	0,9258
11	284,15	0,01312	0,9997	66	339,15	0,2615	0,9799	145	418,15	4,155	0,9214
12	285,15	0,01401	0,9996	67	340,15	0,2733	0,9793	155	428,15	5,433	0,9121
13	286,15	0,01497	0,9994	68	341,15	0,2856	0,9788	160	433,15	6,181	0,9073
14	287,15	0,01597	0,9993	69	342,15	0,2984	0,9782	165	438,15	7,008	0,9024
15	288,15	0,01704	0,9992	70	343,15	0,3116	0,9777	170	443,15	7,920	0,8973
16	289,15	0,01817	0,9990	71	344,15	0,3253	0,9770	175	448,15	8,924	0,8921
17	290,15	0,01936	0,9988	72	345,15	0,3396	0,9765	180	453,15	10,027	0,8869
18	291,15	0,02062	0,9987	73	346,15	0,3543	0,9760	185	458,15	11,233	0,8815
19	292,15	0,02196	0,9985	74	347,15	0,3696	0,9753	190	463,15	12,551	0,8760
20	293,15	0,02337	0,9983	75	348,15	0,3855	0,9748	195	468,15	13,987	0,8704
21	294,15	0,24850	0,9981	76	349,15	0,4019	0,9741	200	473,15	15,550	0,8647
22	295,15	0,02642	0,9978	77	350,15	0,4189	0,9735	205	478,15	17,243	0,8588
23	296,15	0,02808	0,9976	78	351,15	0,4365	0,9729	210	483,15	19,077	0,8528
24	297,15	0,02982	0,9974	79	352,15	0,4547	0,9723	215	488,15	21,060	0,8467
25	298,15	0,03166	0,9971	80	353,15	0,4736	0,9716	220	493,15	23,198	0,8403
26	299,15	0,03360	0,9968	81	354,15	0,4931	0,9710	225	498,15	25,501	0,8339
27	300,15	0,03564	0,9966	82	355,15	0,5133	0,9704	230	503,15	27,976	0,8273
28	301,15	0,03778	0,9963	83	356,15	0,5342	0,9697	235	508,15	30,632	0,8205
29	302,15	0,04004	0,9960	84	357,15	0,5557	0,9691	240	513,15	33,478	0,8136
30	303,15	0,04241	0,9957	85	358,15	0,5780	0,9684	245	518,15	36,523	0,8065
31	304,15	0,04491	0,9954	86	359,15	0,6011	0,9678	250	523,15	39,776	0,7992
32	305,15	0,04753	0,9951	87	360,15	0,6249	0,9671	255	528,15	43,246	0,7916
33	306,15	0,05029	0,9947	88	361,15	0,6495	0,9665	260	533,15	46,943	0,7839
34	307,15	0,05318	0,9944	89	362,15	0,6749	0,9658	265	538,15	50,877	0,7759
35	308,15	0,05622	0,9940	90	363,15	0,7011	0,9652	270	543,15	55,058	0,7678
36	309,15	0,05940	0,9937	91	364,15	0,7281	0,9644	275	548,15	59,496	0,7593
37	310,15	0,06274	0,9933	92	365,15	0,7561	0,9638	280	553,15	64,202	0,7505
38	311,15	0,06624	0,9930	93	366,15	0,7849	0,9630	285	558,15	69,186	0,7415
39	312,15	0,06991	0,9927	94	367,15	0,8146	0,9624	290	563,15	74,461	0,7321
40	313,15	0,07375	0,9923	95	368,15	0,8453	0,9616	295	568,15	80,037	0,7223
41	314,15	0,07777	0,9919	96	369,15	0,8769	0,9610	300	573,15	85,927	0,7122
42	315,15	0,08198	0,9915	97	370,15	0,9094	0,9602	305	578,15	92,144	0,7017
43	316,15	0,09639	0,9911	98	371,15	0,9430	0,9596	310	583,15	98,70	0,6906
44	317,15	0,09100	0,9907	99	372,15	0,9776	0,9586	315	588,15	105,61	0,6791
45	318,15	0,09582	0,9902	100	373,15	1,0133	0,9581	320	593,15	112,89	0,6669
46	319,15	0,10086	0,9898	102	375,15	1,0878	0,9567	325	598,15	120,56	0,6541
47	320,15	0,10612	0,9894	104	377,15	1,1668	0,9552	330	603,15	128,63	0,6404
48	321,15	0,11162	0,9889	106	379,15	1,2504	0,9537	340	613,15	146,05	0,6102
49	322,15	0,11736	0,9884	108	381,15	1,3390	0,9522	350	623,15	165,35	0,5743
50	323,15	0,12335	0,9880	110	383,15	1,4327	0,9507	360	633,15	186,75	0,5275
51	324,15	0,12961	0,9876	112	385,15	1,5316	0,9491	370	643,15	210,54	0,4518
52	325,15	0,13613	0,9871	114	387,15	1,6362	0,9476	374,15	647,30	221,20	0,3154
53	326,15	0,14293	0,9862	116	389,15	1,7465	0,9460				
54	327,15	0,15002	0,9862	118	391,15	1,8628	0,9445				

G-at_npsh_b_sc

FLOW RESISTANCE

TABLE OF FLOW RESISTANCE IN BENDS, VALVES AND GATES

The flow resistance is calculated using the equivalent pipeline length method according to the table below:

ACCESSORY TYPE	DN											
	25	32	40	50	65	80	100	125	150	200	250	300
	Equivalent pipeline length (m)											
45° bend	0,2	0,2	0,4	0,4	0,6	0,6	0,9	1,1	1,5	1,9	2,4	2,8
90° bend	0,4	0,6	0,9	1,1	1,3	1,5	2,1	2,6	3,0	3,9	4,7	5,8
90° smooth bend	0,4	0,4	0,4	0,6	0,9	1,1	1,3	1,7	1,9	2,8	3,4	3,9
Union tee or cross	1,1	1,3	1,7	2,1	2,6	3,2	4,3	5,3	6,4	7,5	10,7	12,8
Gate	-	-	-	0,2	0,2	0,2	0,4	0,4	0,6	0,9	1,1	1,3
Non return valve	1,1	1,5	1,9	2,4	3,0	3,4	4,7	5,9	7,4	9,6	11,8	13,9

G-a-pcv-en_a_th

The table is valid for the Hazen Williams coefficient $C=100$ (cast iron pipework);

for steel pipework, multiply the values by 1,41;

for stainless steel, copper and coated cast iron pipework, multiply the values by 1,85;

When the **equivalent pipeline length** has been determined, the flow resistance is obtained from the table of flow resistance.

The values given are guideline values which are bound to vary slightly according to the model, especially for gate valves and non-return valves, for which it is a good idea to check the values supplied by manufacturers.

VOLUMETRIC CAPACITY

Litres per minute l/min	Cubic metres per hour m ³ /h	Cubic feet per hour ft ³ /h	Cubic feet per minute ft ³ /min	Imp. gal. per minute Imp. gal./min	US gal. per minute Us gal./min
1,000	0,0600	2,1189	0,0353	0,2200	0,2642
16,6667	1,000	35,3147	0,5886	3,6662	4,4029
0,4719	0,0283	1,000	0,0167	0,1038	0,1247
28,3168	1,6990	60,0000	1,000	6,2288	7,4805
4,5461	0,2728	9,6326	0,1605	1,000	1,2009
3,7854	0,2271	8,0208	0,1337	0,8327	1,000

PRESSURE AND HEAD

Newton per square metre N/m ²	kilo Pascal kPa	bar bar	Pound force per square inch psi	metre of water m H ₂ O	millimetre of mercury mm Hg
1,000	0,0010	1 x 10 ⁻⁵	1.45 x 10 ⁻⁴	1.02 x 10 ⁻⁴	0,0075
1000,0000	1,000	0,0100	0,1450	0,1020	7,5006
1 x 10 ⁵	100,0000	1,000	14,5038	10,1972	750,0638
6894,7570	6,8948	0,0689	1,000	0,7031	51,7151
9806,6500	9,8067	0,0981	1,4223	1,000	73,5561
133,3220	0,1333	0,0013	0,0193	0,0136	1,000

LENGTH

millimetre mm	centimetre cm	metre m	inch in	foot ft	yard yd
1,000	0,1000	0,0010	0,0394	0,0033	0,0011
10,0000	1,000	0,0100	0,3937	0,0328	0,0109
1000,0000	100,0000	1,000	39,3701	3,2808	1,0936
25,4000	2,5400	0,0254	1,000	0,0833	0,0278
304,8000	30,4800	0,3048	12,0000	1,000	0,3333
914,4000	91,4400	0,9144	36,0000	3,0000	1,000

VOLUME

cubic metre m ³	litre litro	millilitre ml	imp. Gallon imp. gal.	US gallon US gal.	cubic foot ft ³
1,000	1000,0000	1 x 10 ⁶	219,9694	264,1720	35,3147
0,0010	1,000	1000,0000	0,2200	0,2642	0,0353
1 x 10 ⁻⁶	0,0010	1,000	2.2 x 10 ⁻⁴	2.642 x 10 ⁻⁴	3.53 x 10 ⁻⁵
0,0045	4,5461	4546,0870	1,000	1,2009	0,1605
0,0038	3,7854	3785,4120	0,8327	1,000	0,1337
0,0283	28,3168	28316,8466	6,2288	7,4805	1,000

G-at_pp-en_a_sc

FURTHER PRODUCT SELECTION AND DOCUMENTATION

Xylect™

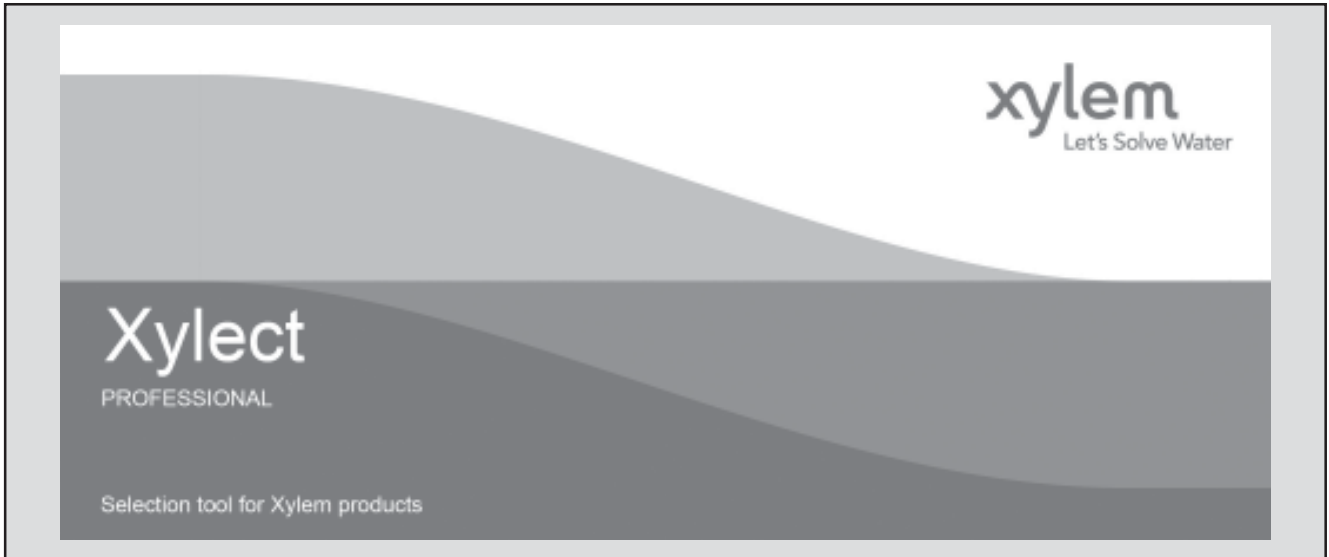

Xylect™ is pump solution selection software with an extensive online database of product information across the entire Lowara, and Vogel range of pumps and related products, with multiple search options and helpful project management facilities. The system holds up-to-date product information on thousands of products and accessories.

The possibility to search by applications and the detailed information output given makes it easy to make the optimal selection without having detailed knowledge about the Lowara and Vogel products.

The search can be made by:

- Application
- Product type
- Duty point

Xylect™ gives a detailed output:

- List with search results
- Performance curves (flow, head, power, efficiency, NPSH)
- Motor data
- Dimensional drawings
- Options
- Data sheet printouts
- Document downloads incl dxf files

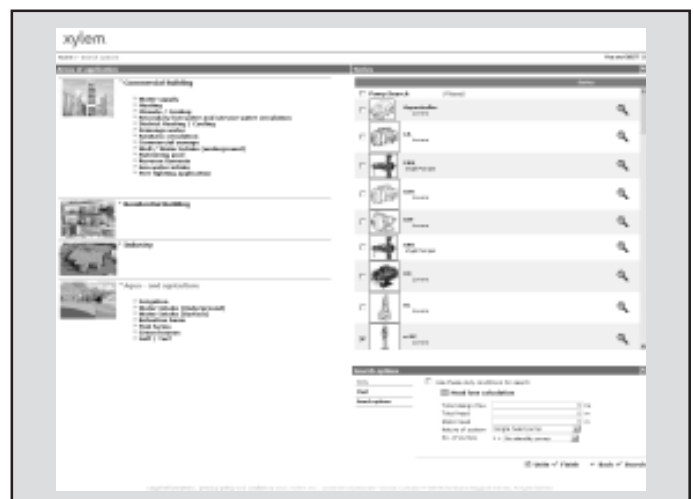

The search by application guides users not familiar with the product range to the right choice.

FURTHER PRODUCT SELECTION AND DOCUMENTATION

Xylect™

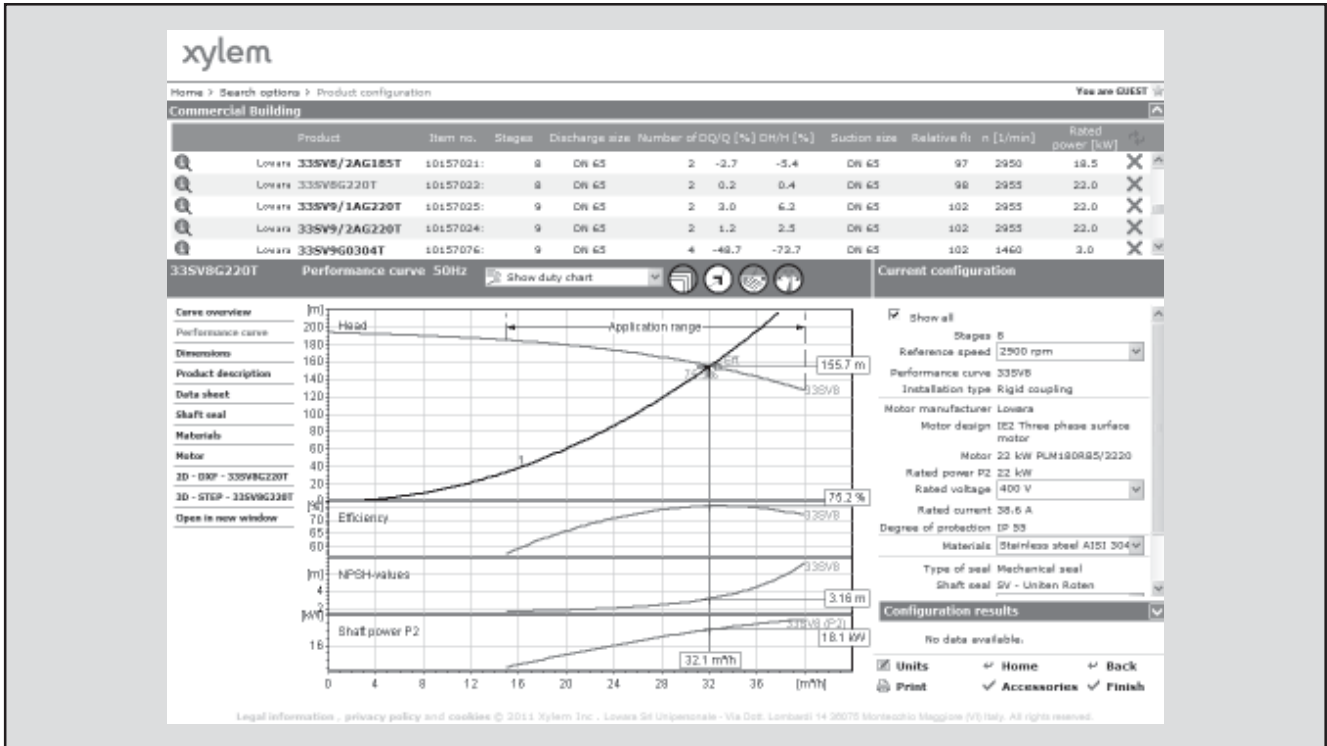

The detailed output makes it easy to select the optimal pump from the given alternatives.

The best way to work with Xylect™ is to create a personal account. This makes it possible to:

- Set own standard units
- Create and save projects
- Share projects with other Xylect™ users

Every user has a My Xylect space, where all projects are saved.

For more information about Xylect™ please contact our sales network or visit www.xylect.com.

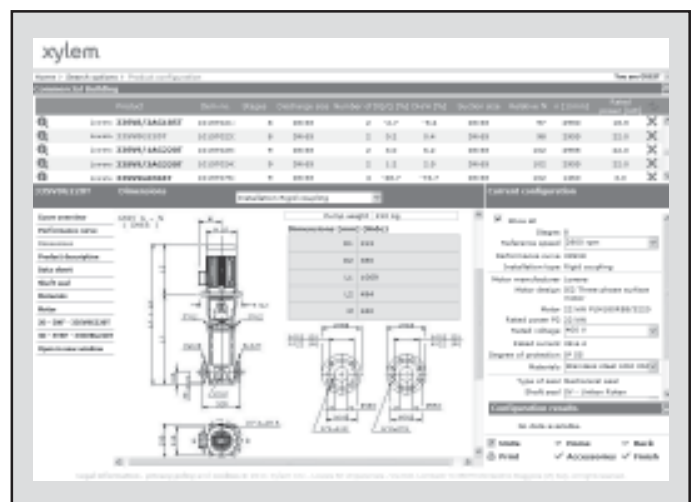

Dimensional drawings appear on the screen and can be downloaded in dxf format.

Xylem |'zīləm|

- 1) The tissue in plants that brings water upward from the roots;
- 2) a leading global water technology company.

We're approximately 12,700 people unified in a common purpose: creating innovative solutions to meet our world's water needs. Developing new technologies that will improve the way water is used, conserved, and re-used in the future is central to our work. We move, treat, analyze, and return water to the environment, and we help people use water efficiently, in their homes, buildings, factories and farms. In more than 150 countries, we have strong, long-standing relationships with customers who know us for our powerful combination of leading product brands and applications expertise, backed by a legacy of innovation.

For more information on how Xylem can help you, go to xylem.com.



Legal head office
Xylem Water Solutions Italia Srl

Via Gioacchino Rossini 1/A
20020 - Lainate (MI) - Italy
Tel. (+39) 02 90358.1
Fax (+39) 02 9019990
www.xylemwatersolutions.com

For information and technical support
Xylem Service Italia Srl

Via Dottor Vittorio Lombardi 14
36075 - Montecchio Maggiore (VI) - Italy
Tel. (+39) 0444 707111
Fax (+39) 0444 491043
www.lowara.com

Xylem Water Solutions Italia Srl reserves the right to make modification without prior notice.
Lowara, Xylem are trademarks of Xylem Inc. or one of its subsidiaries
© 2013 Xylem, Inc.